



ELKHALIL

one name supplies it all

**FIT
FIT
FIT
FIT**

**FURNITURE FITTINGS
SYSTEMS**

WWW.ELKHALIL-WOOD.COM

Concealed Hinges

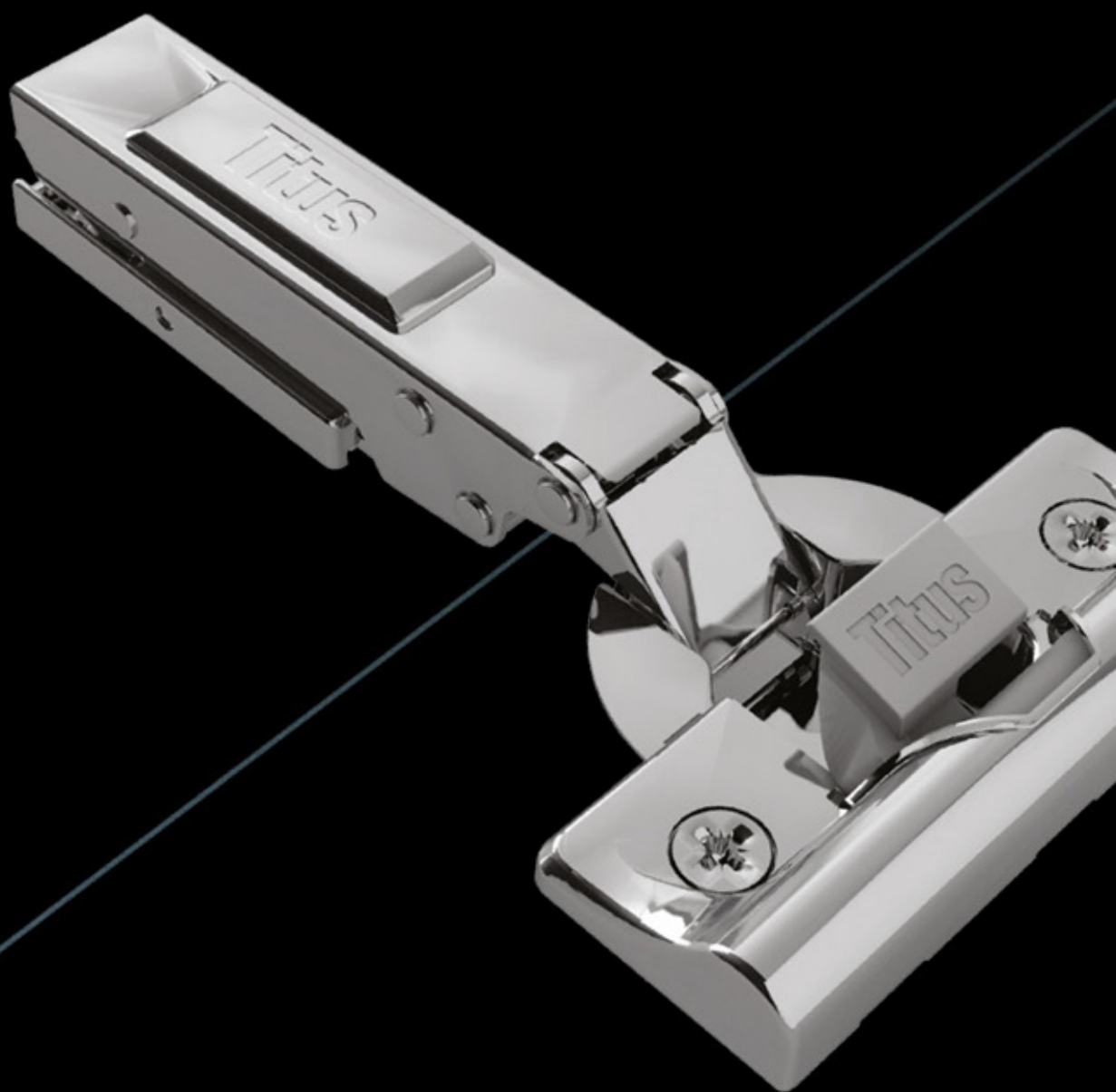

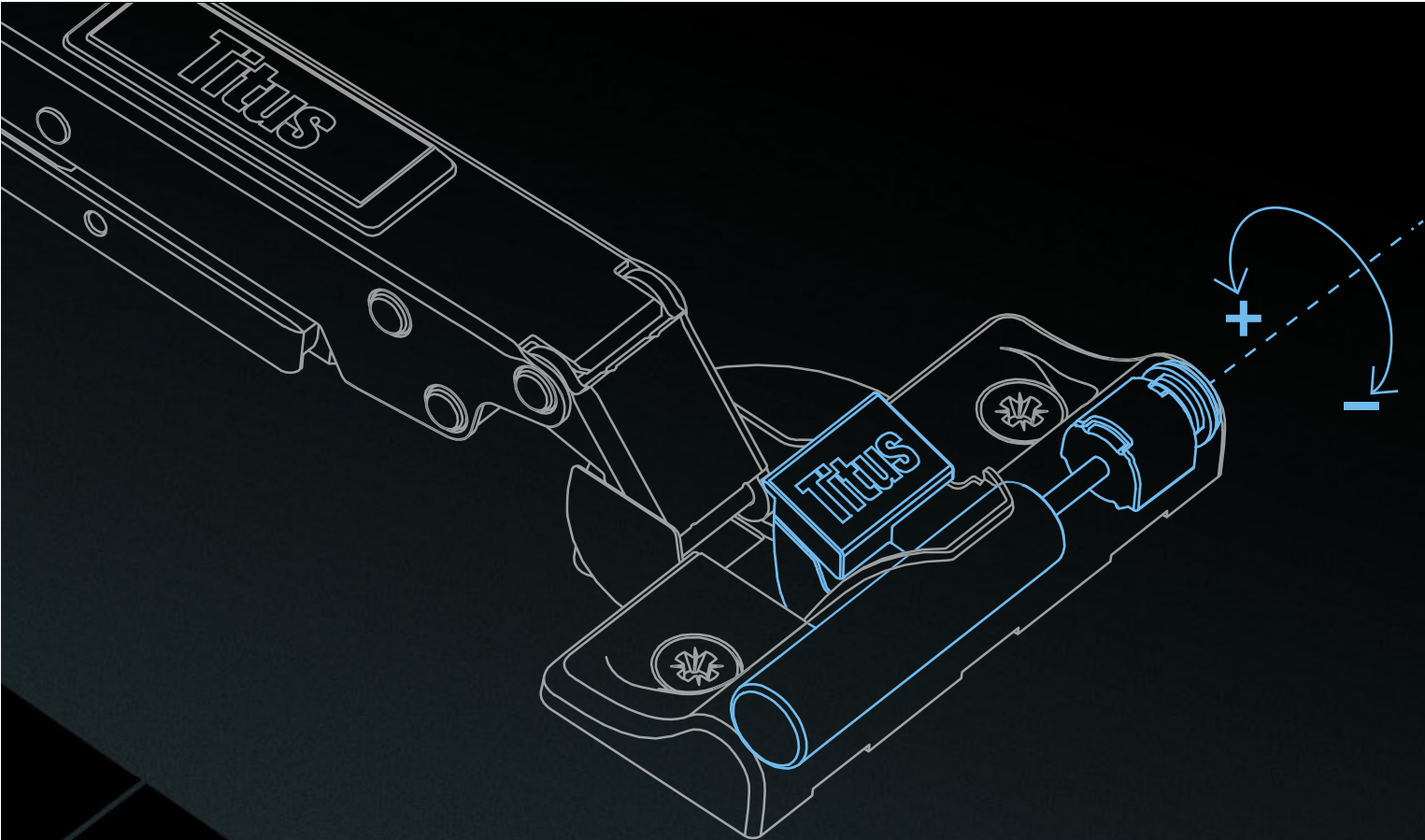

Confident Close

The hinge is designed to provide consumer preferred way of soft closing action.

- Fast closing
- Late start of deceleration action
- Quiet landing with SoftTouch

Based on independent consumer researches.

One-for-All

- Damping on the hinge cup
- Damper, positioned transversal to the hinge allows for easy introduction of various hinge versions
- Damped and non-damped version on one mounting plate platform

Adjustable Damping

Flexibility to tune performance to wide range of applications

- Consistent performance over a wide range of doors of different sizes and weights
- Easy accessible button for intuitive and quick adjustment

Titus Damper Inside

- Efficient damping at any closing speed
- Reliable closing
- Damping force consistency

T-TYPE-I 110

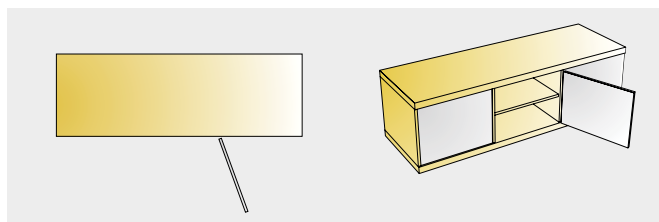

- ▶ Opening angle 110°
- ▶ Drilling diameter for hinge cup 35 mm
- ▶ Drilling depth 12 mm
- ▶ Hinge on plate mounting system 3 Way snap-on

Drilling Pattern		Full Overlay	Half Overlay	inset
------------------	--	--------------	--------------	-------

With integrated Silent System.

Mounting Option	Mounting hole Ø×T mm	Full overlay 150 Pcs.	Half overlay 150 Pcs.	Inset 150 Pcs.
screw on	-	100TK143	100TK144	100TK145
Pre-mounted 10.5mm expanding dowels	ø 10.5 x 5	100TK181	100TK182	100TK183

Damping adjustment Door adjustment

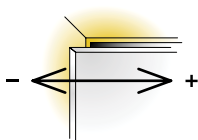
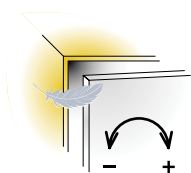

Side adjustment
+3/-1mm

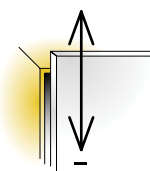

Height adjustment
+2/-2mm

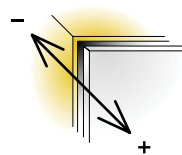

Depth adjustment
+4/-1mm

T-TYPE- 110

INTEGRATED SILENT SYSTEM

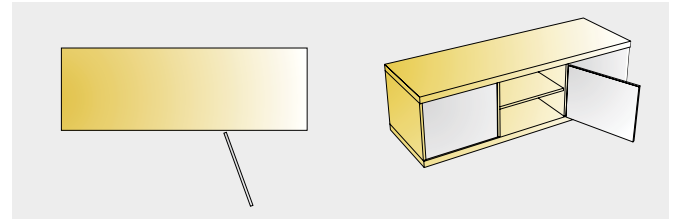

- ▶ Opening angle 110°
- ▶ Drilling diameter for hinge cup 35 mm
- ▶ Drilling depth 12 mm
- ▶ Hinge on plate mounting system 3 Way snap-on

Drilling Pattern

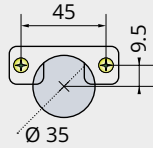

Full Overlay

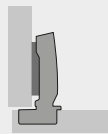

Half Overlay

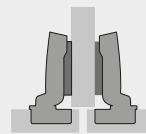

inset

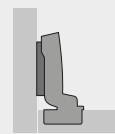

With integrated Silent System.

Mounting Option	Mounting hole Ø×T mm	Full overlay 150 Pcs.	Half overlay 150 Pcs.	Inset 150 Pcs.
screw on	-	100TK140	100TK141	100TK142
Pre-mounted 10.5mm expanding dowels	Ø 10.5 x 5	100TK180	100TK181	100TK182

Damping adjustment

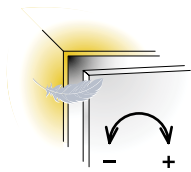

Door adjustment

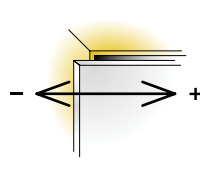

Side
adjustment
+3/-1mm

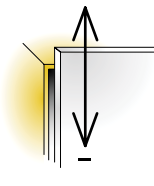

Height
adjustment
+2/-2mm

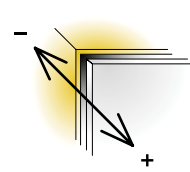

Depth
adjustment
+4/-1mm

T-TYPE- I-95

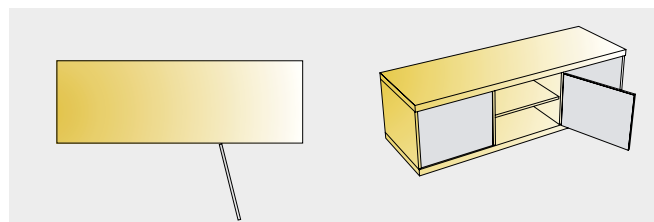

- ▶ Opening angle 95°
- ▶ Drilling diameter for hinge cup 35 mm
- ▶ Drilling depth 12 mm
- ▶ Hinge on plate mounting system 3 Way snap-on

Drilling Pattern

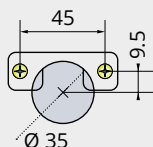

Full Overlay

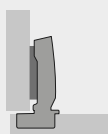

Half Overlay

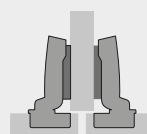

inset

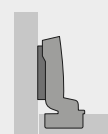

With integrated Silent System.

Mounting Option	Mounting hole Ø×T mm	Full overlay 150 Pcs.	Half overlay 150 Pcs.	Inset 150 Pcs.
screw on	-	100TK189	100TK190	100TK176

Damping adjustment

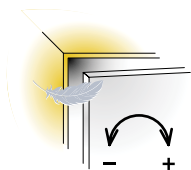

Door adjustment

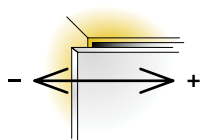

Side
adjustment
+3/-1mm

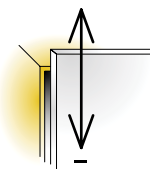

Height
adjustment
+2/-2mm

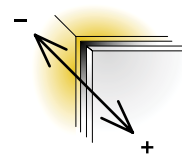

Depth
adjustment
+4/-1mm

T-TYPE 95

INTEGRATED SILENT SYSTEM

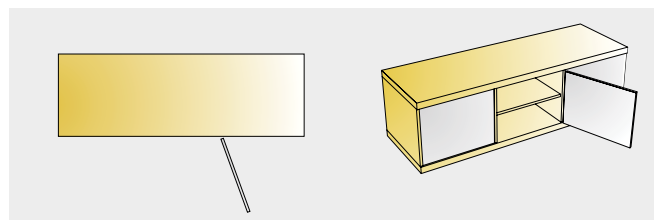

- ▶ Opening angle 95°
- ▶ Drilling diameter for hinge cup 35 mm
- ▶ Drilling depth 12 mm
- ▶ Hinge on plate mounting system 3 Way snap-on

Drilling Pattern

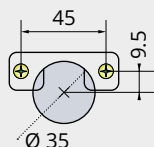

Full Overlay

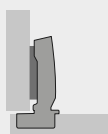

Half Overlay

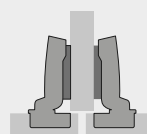

inset

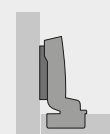

With integrated Silent System.

Mounting Option	Mounting hole Ø×T mm	Full overlay 150 Pcs.	Half overlay 150 Pcs.	Inset 150 Pcs.
screw on	-	100TK187	100TK188	100TK175

Damping adjustment

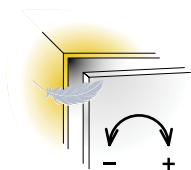

Door adjustment

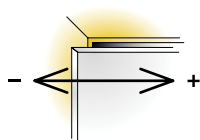

Side
adjustment
+3/-1mm

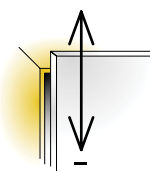

Height
adjustment
+2/-2mm

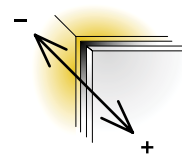

Depth
adjustment
+4/-1mm

T-TYPE 170

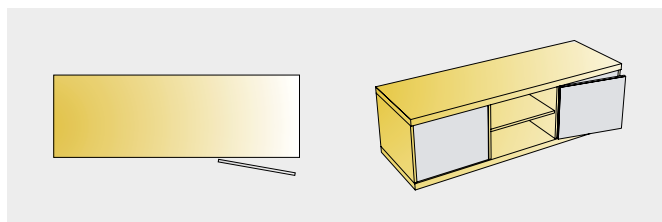
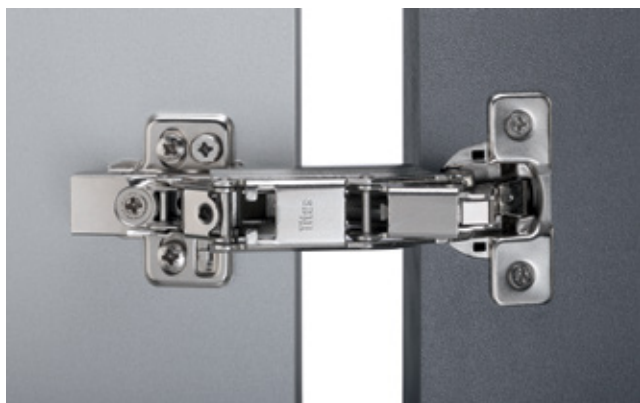

- ▶ Opening angle 170°
- ▶ Drilling diameter for hinge cup 35 mm
- ▶ Drilling depth 12 mm
- ▶ Hinge on plate mounting system 3 Way snap-on

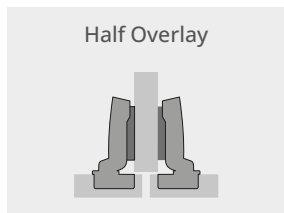
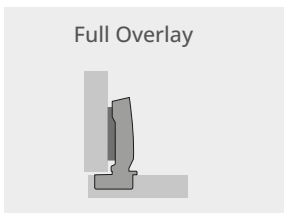
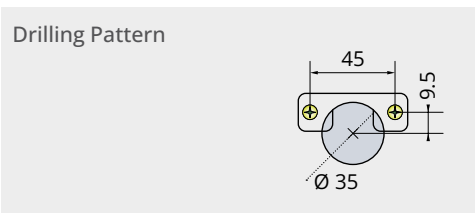

Mounting Option	Mounting hole Ø×T mm	Full overlay 50 Pcs.	Half overlay 50 Pcs.
screw on	-	100TK148	100TK149

Damping adjustment Door adjustment

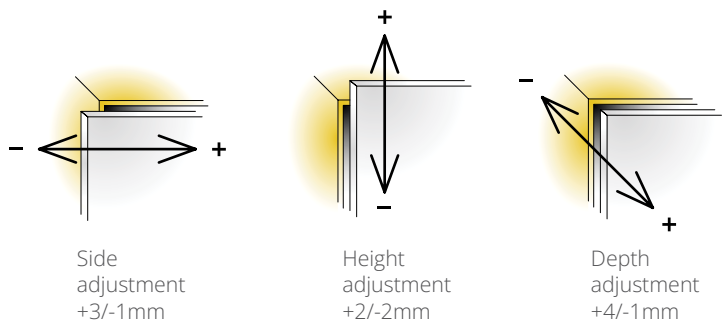

T-TYPE 110/45°

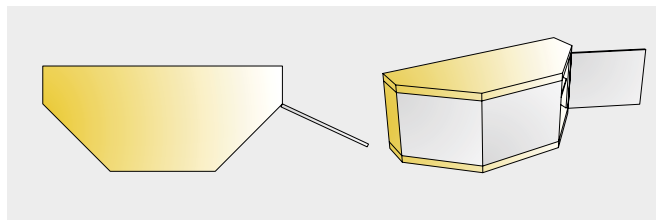

- ▶ Opening angle 110°
- ▶ Drilling diameter for hinge cup 35 mm
- ▶ Drilling depth 12 mm
- ▶ Hinge on plate mounting system 3 Way snap-on

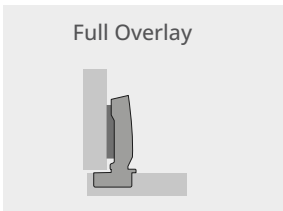
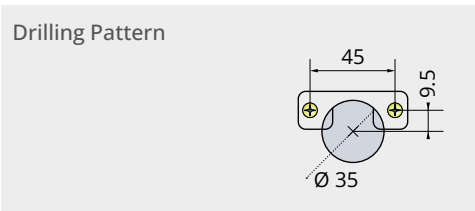

Mounting Option	Mounting hole Ø×T mm	Full overlay 100 Pcs.
screw on	-	100TK146

Damping adjustment Door adjustment

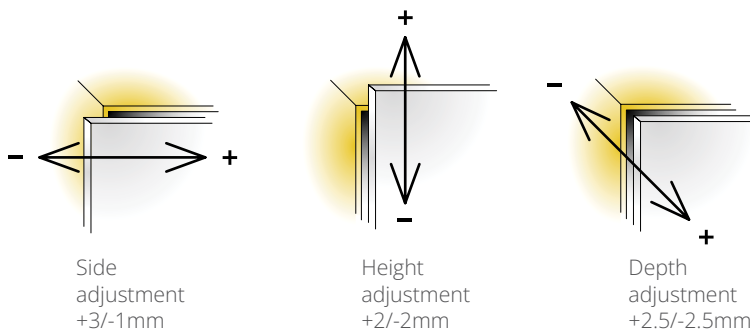

T-TYPE 110/90°

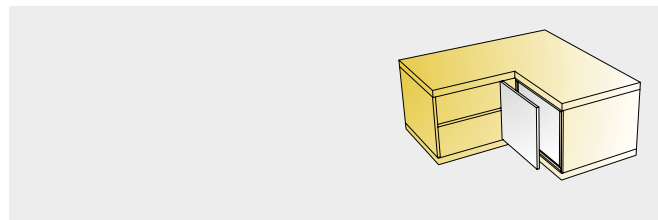

- ▶ Opening angle 110°
- ▶ Drilling diameter for hinge cup 35 mm
- ▶ Drilling depth 12 mm
- ▶ Hinge on plate mounting system 3 Way snap-on

Drilling Pattern

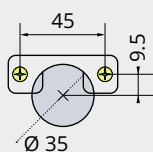

inset

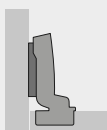

Mounting Option	Mounting hole Ø×T mm	inset 100Pcs.
screw on	-	100TK147

Damping adjustment

Door adjustment

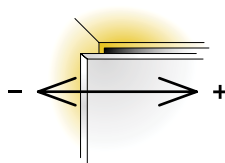
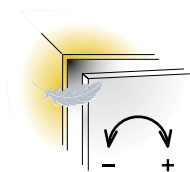

Side
adjustment
+3/-1mm

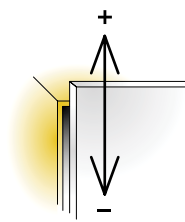

Height
adjustment
+2/-2mm

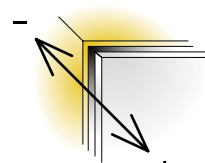

Depth
adjustment
+4/-1mm

S-TYPE FOR PIE-CUT CORNER CABINET

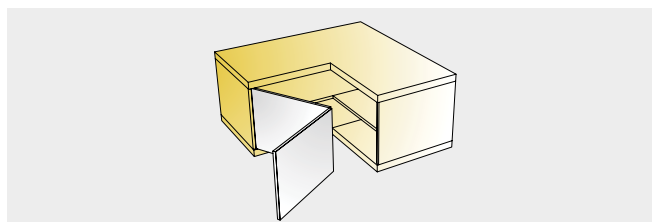

- ▶ Opening angle 110°
- ▶ Drilling diameter for hinge cup 35 mm
- ▶ Drilling depth 11 mm
- ▶ Hinge on plate mounting system snap-on

Drilling Pattern

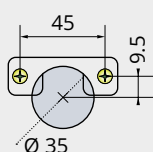

Full Overlay

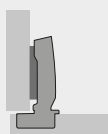

Mounting Option

Mounting hole
Ø×T mm

Full overlay
100 Pcs.

screw on

-

100TK191

Damping adjustment

Door adjustment

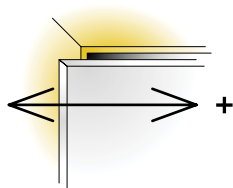

Side
adjustment
+3/-1mm

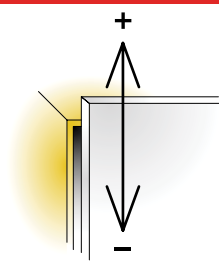

Height
adjustment
+2/-2mm

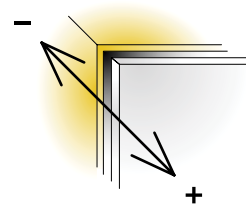

Depth
adjustment
+5/-1.5mm

TERABLACK T-TYPE 110

INTEGRATED SILENT SYSTEM

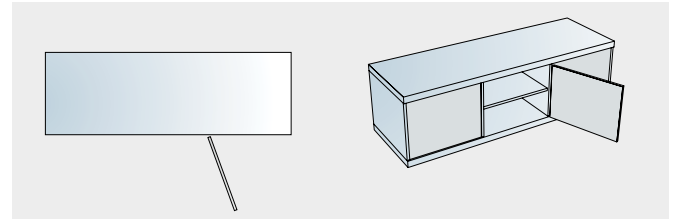

- ▶ Opening angle 110°
- ▶ Drilling diameter for hinge cup 35 mm
- ▶ Drilling depth 12 mm
- ▶ Hinge on plate mounting system 3 Way snap-on

Drilling Pattern

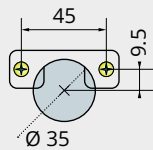

Full Overlay

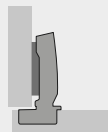

Half Overlay

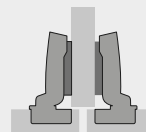

inset

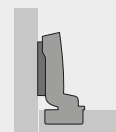

With integrated Silent System.

Mounting Option	Mounting hole Ø×T mm	Full overlay 150 Pcs.	Half overlay 150 Pcs.	Inset 150 Pcs.
Pre-mounted 10.5mm expanding dowels	Ø 10.5 x 5	100TK177	100TK186	100TK178

Damping adjustment

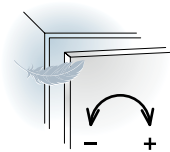

Door adjustment

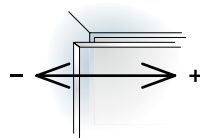

Side
adjustment
+3/-1mm

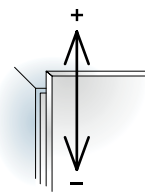

Height
adjustment
+2/-2mm

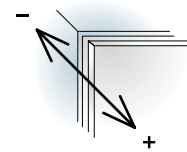

Depth
adjustment
+4/-1mm

